

INPE-5245-PRE/1676

**S-BAND ANTENNA FOR THE MECB
REMOTE SENSING SATELLITE (SSR-1)**

**Carlos Alberto Iennaco Miranda
Vicente de Paulo Damasceno da Costa Júnior**

**INPE
SÃO JOSÉ DOS CAMPOS
Julho de 1991**

SECRETARIA DA CIÊNCIA E TECNOLOGIA
INSTITUTO NACIONAL DE PESQUISAS ESPACIAIS

INPE-5245-PRE/1676

S-BAND ANTENNA FOR THE MECB
REMOTE SENSING SATELLITE (SSR-1)

Carlos Alberto Iennaco Miranda
Vicente de Paulo Damasceno da Costa Júnior

Apresentado no 1º Simpósio Brasileiro de
Tecnologia Aeroespacial, São José dos Campos,
agosto de 1990

INPE
SÃO JOSÉ DOS CAMPOS
Julho de 1991

CDU: 621.391

Key Words: Antennas, Satellite Antennas

S-BAND ANTENNA FOR THE MECB REMOTE SENSING SATELLITE (SSR-1)

Carlos Alberto Iennaco Miranda
Vicente de Paulo Damasceno da Costa Júnior

Instituto Nacional de Pesquisas Espaciais - INPE
Av. dos Astronautas, 1758 - C.P. 515
12201 - São José dos Campos - SP

1. INTRODUCTION

The Imaging Instrument Subsystem of the first MECB Remote Sensing Satellite (SSR1) requires the design of an right handed circularly polarized antenna for data transmission at 2250 MHz. The antenna shall produce a shaped radiation pattern that concentrates the radiated energy into a cone with a full cone angle of 130 degrees corresponding to the coverage region. The optimum is a shaped-conical radiation pattern with a maximum gain at the rim of the cone and gain decreasing to a minimum at the center of the cone to provide uniform signal strength at the receiver throughout the satellite pass.

This antenna is to be mounted on the earthward side of the spacecraft within an area defined by the launcher and satellite structural specifications (Figure 1).

This work discusses two types of antennas which may be used to meet coverage requirements (Figure 2). Quadrifilar helices with a integral number of turns and crossed dipoles above a reflector plane have been investigated and compared to each other.

2. QUADRIFILAR HELIX ANTENNA

Quadrifilar helix was developed by Kilgus (1968) and it has been applied in a variety of spacecraft programs.

A quadrifilar is a four element helical antenna with each of the four elements terminating in two radial portions (Figure 3). The four top radials connect the helical portions to the feed region and the bottom radials are shorted together.

Two opposite elements are fed in antiphase producing a bifilar helix. The bifilars are fed in phase quadrature to produce a quadrifilar helix.

The helix can be described by the following parameters (Figure 3):

Ro - Radius
P - Pitch distance for one element measured along the axis of the helix
N - Number of the turns of one element
Lax - Axial length = P*N

The shaped conical radiation patterns necessary to meet the coverage requirements can be realized by the proper choice of helical parameters. Calculated radiation patterns with and without a ground plane are presented for helices with one to three turns in Figures 4 to 9. These radiation patterns were calculated utilizing the method of moments (Julian, A.J. et al, 1982).

Several techniques to feed the bifilars are possible. As with all coaxially fed balanced antennas, the bifilar requires a balun. Two known balun designs that can be applied to each bifilar are the compensated balun (Roberts; W.K., 1957) and the split sheet (Silver; S., 1949). In both cases, additional impedances networks are required to match the balun design to the coax and bifilar impedance. The 90 degrees phase relationship between bifilars needed to produce the quadrifilar can be achieved utilizing a quadrature hybrid.

3. CROSSED-DIPOLES ANTENNA

The crossed-dipoles antenna consists of two orthogonal dipoles mounted approximately half wavelength above a reflector plane and fed equal power, 90 degrees out of phase (Figure 10). Feeding is accomplished by a split sheet coaxial balun (Silver; S., 1949) and self phasing the dipoles where the desired 90 degrees phase difference is obtained by designing the orthogonal dipoles such that one is large relative to the desired resonant frequency length, and therefore inductive, while the other is smaller, and therefore capacitive.

The radiation patterns for the crossed-dipoles have been computed by numerical integration utilizing method of moments (Rydahl; Ole, 1975) where the variables and parameters used are defined in Figure 10. Figure 11 shows the theoretical pattern for the RHCP and LHCP polarizations. A breadboard model for this antenna was constructed and the radiation pattern for the RHCP polarization is shown in Figure 12 and compared to the theoretical result. Figures 13, 14 and 15 show the radiation patterns for a linearly polarized rotating source and Figure 16, the return loss over the operation frequency band.

4. CONCLUSIONS

Computer simulations have shown that, although gain and coverage requirements have been met by two and three turns quadrifilar helices, due their height, these antennas would require deployment mechanisms to be mounted on the satellite structure. A quadrifilar helix with one turn complies with gain requirements and its height meets the satellite configuration but it has a poor axial ratio in some regions when compared with two and three turns helices.

The crossed-dipoles antenna, with dipole wings tilted 150 degrees away from antenna axis was chosen because it provides the required beam shaping with gain values that meet the desired gain pattern curve. It represents a simple, reliable and low-cost approach although its axial ratio figure is worse than that of a quadrifilar helix.

ACKNOWLEDGMENT

The authors are grateful to the manufacture department personnel for the mechanical design and breadboard manufacturing.

REFERENCES

- Julian, A.J.; Logan, J.C.; Rockway, J.W. Mininec: A Mini Numerical Electromagnetics Code, Technical Document, Naval Center Systems Ocean. San Diego, September 6, 1982.
- Kilgus, C.C. Multielement Fractional Turn Helices. IEEE Transactions on Antennas and Propagation, 16(4):499-501, 1968.
- Kilgus, C.C. Resonant Quadrifilar Helices. IEEE Transactions on Antennas and Propagation, 17(3):349-351, 1969.
- Kilgus, C.C. Resonant Quadrifilar Helices Design. Microwave Journal, 13(12):49-54, 1970.
- Kilgus, C.C. Shaped Conical Radiation Pattern Performance of the Backfire Quadrifilar Helix. IEEE Transactions on Antennas and Propagation, 23(3):392-397, 1975.
- Roberts, W.K. A New Wide-Band Balun. Proceedings of IRE, 45(5):1628-1631, 1957.
- Rydahl, O. A Numerical Technique to Predict Scattering From Bodies of Revolution. Lingby, Electromagnetics Institute Technical University Denmark, Dec. 1975.
- Silver, S. Microwave Antenna Theory and Design. New York, McGraw-Hill Book Company Inc., 1949, pp. 246-247.

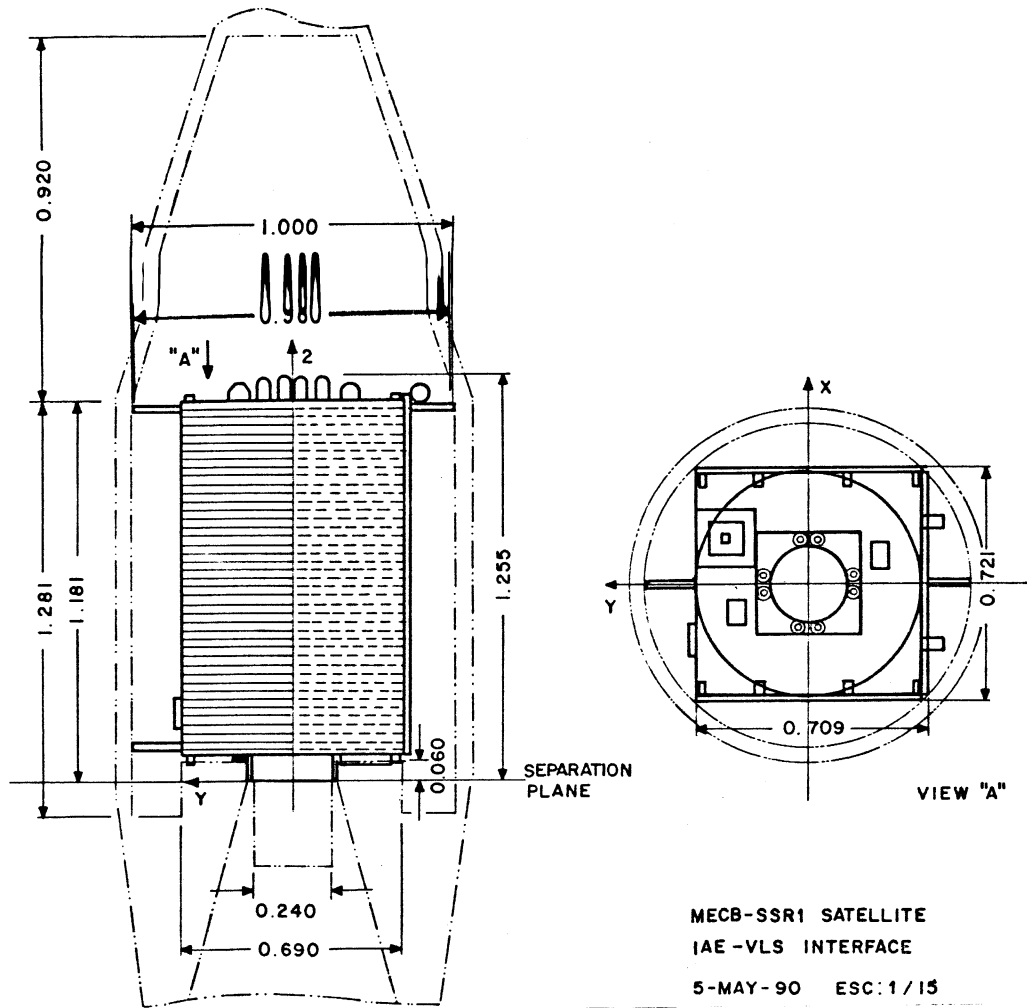

Fig. 1 - Volume limitation.

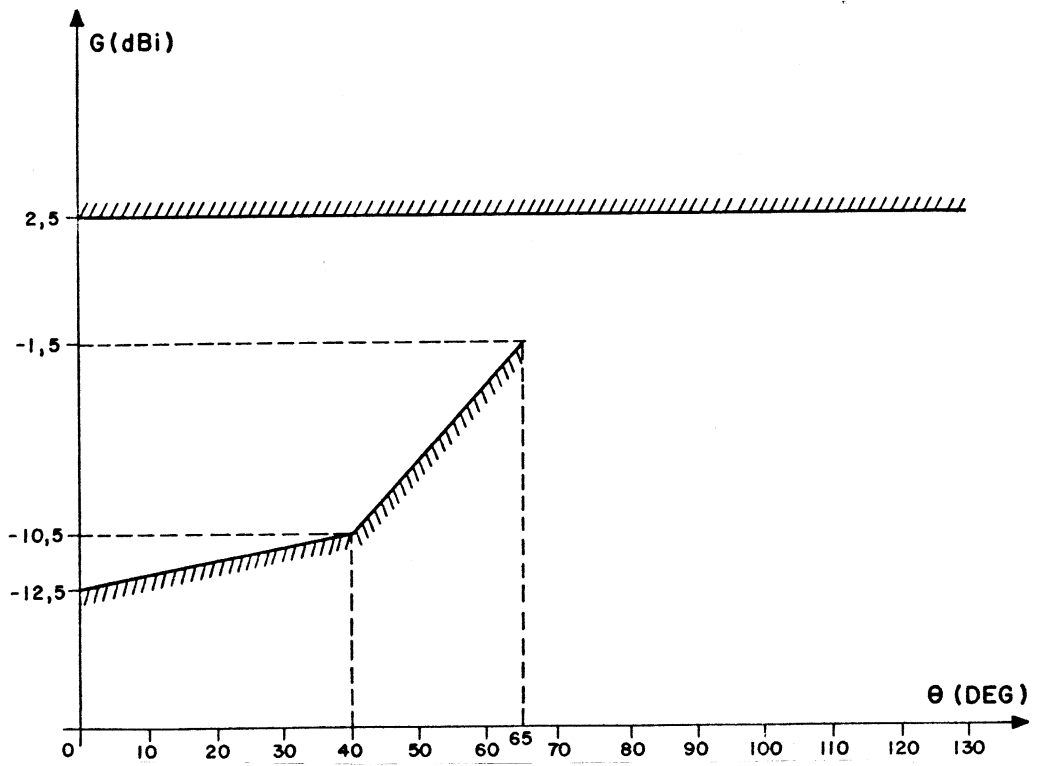

Fig. 2 - Coverage requirements.

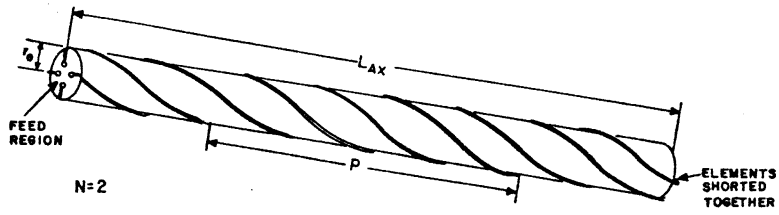
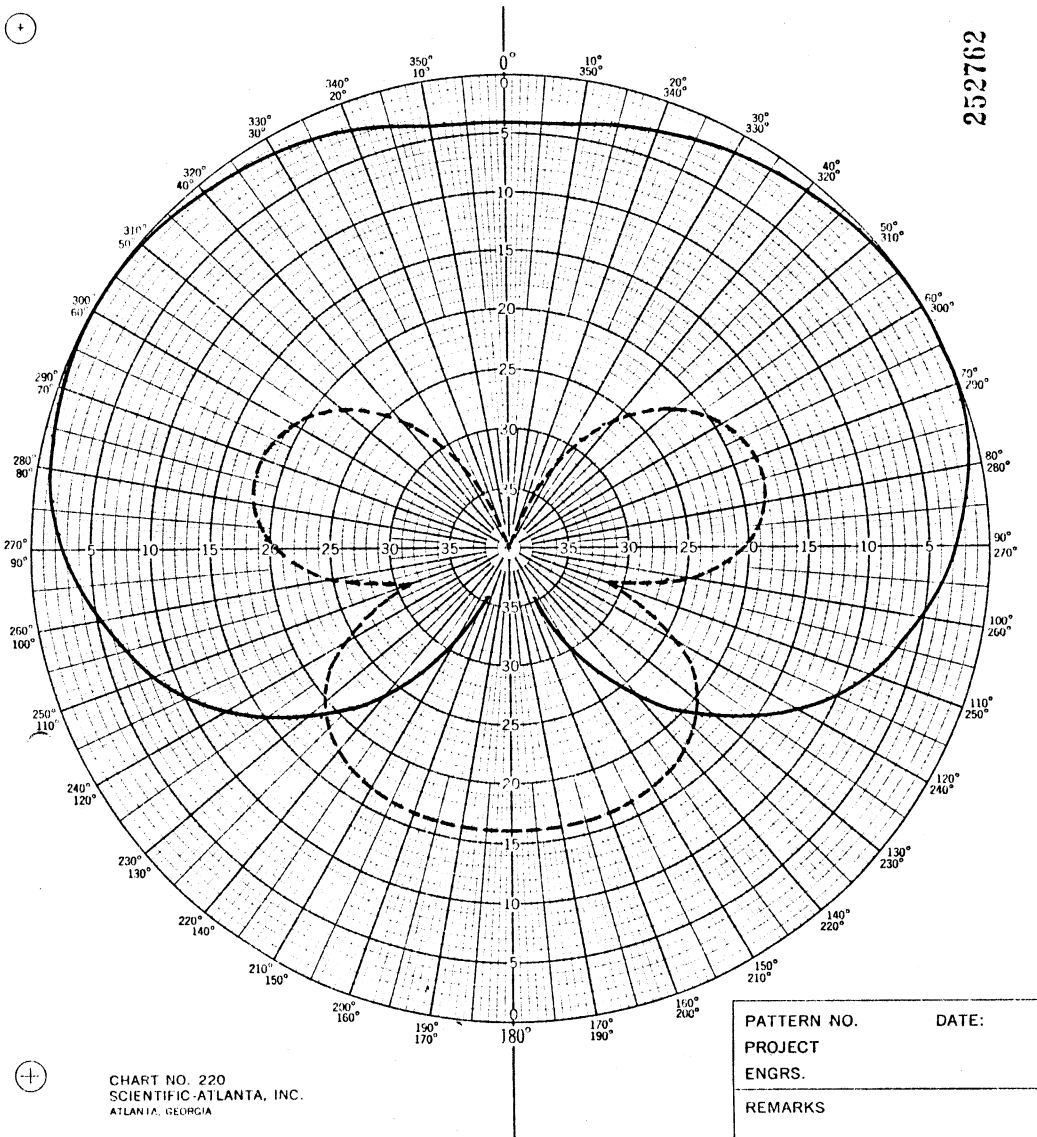

Fig. 3 - Helical parameters.



252762

Fig. 4 - Quadrifilar antenna radiation pattern.

$N = 1$; $R_0 = 0.0125$ m; $L_{ax} = 0.10$ m; $P = 0.10$ m.

———— RHCP - - - - LHCP

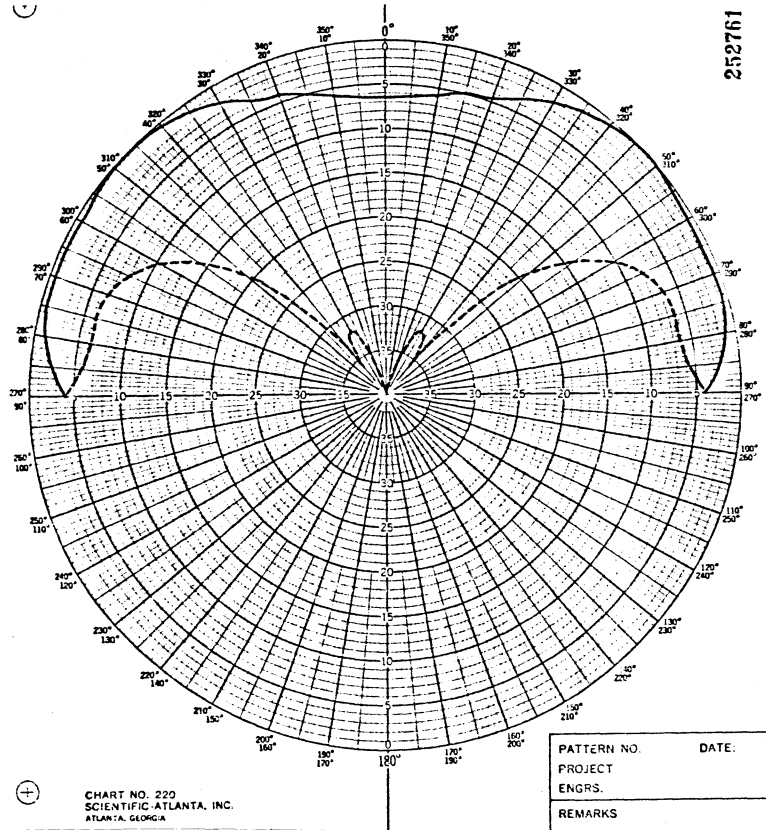

Fig. 5 - Quadrifilar antenna radiation pattern.
Antenna above an infinite ground plane.
 $h = 0.04 \text{ m}$, $R_0 = 0.0125 \text{ m}$, $L_{ax} = 0.10 \text{ m}$, $P = 0.10 \text{ m}$, $N = 1$.
—— RHCP - - - - LHCP

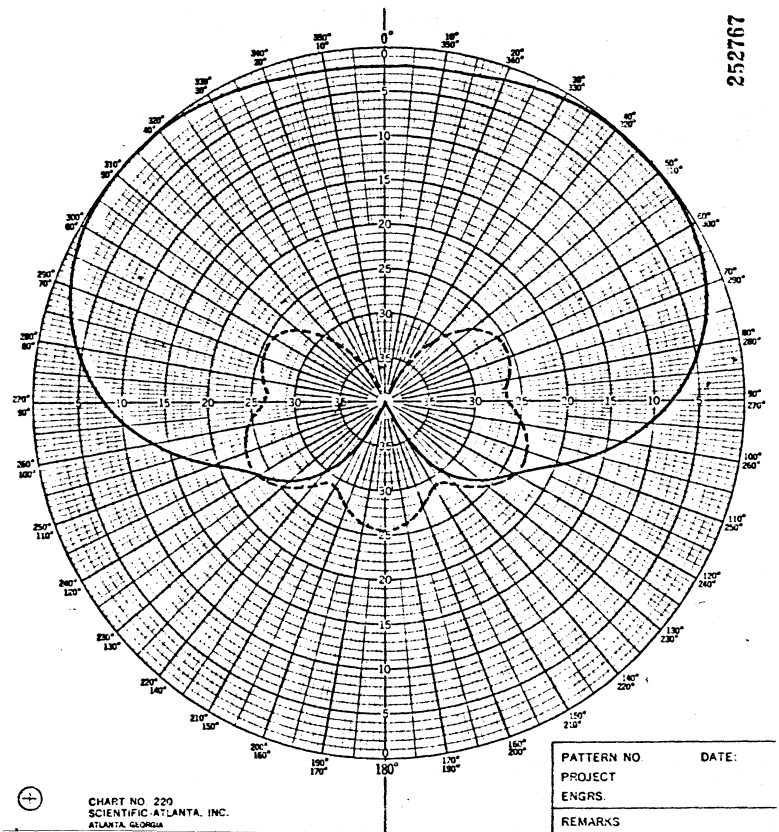

Fig. 6 - Quadrifilar antenna radiation pattern.
 $N = 2$, $R_0 = 0.015 \text{ m}$, $P = 0.07 \text{ m}$, $L_{ax} = 0.14 \text{ m}$.
—— RHCP - - - - LHCP

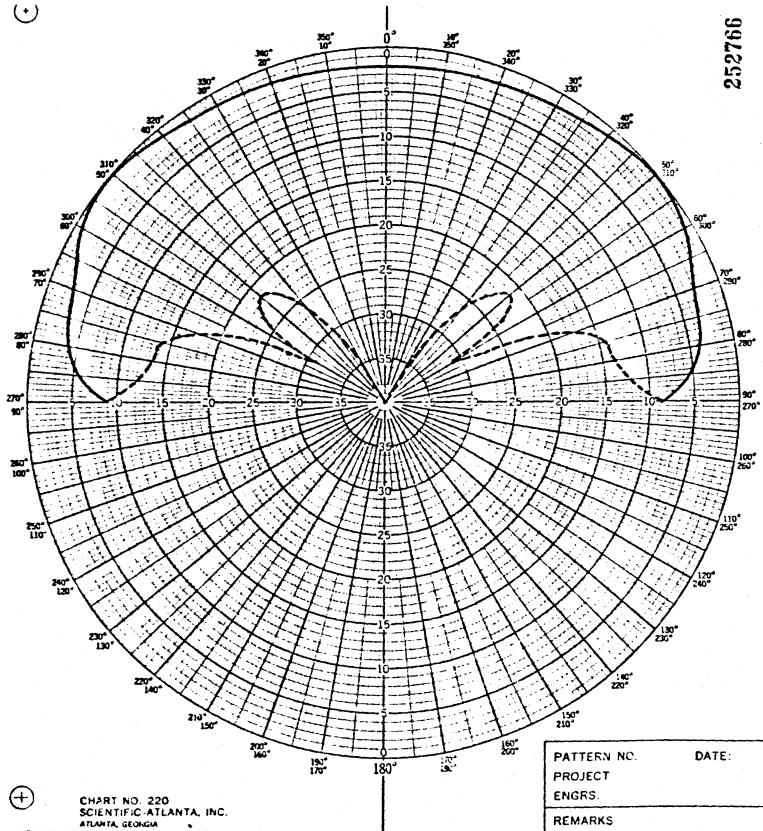

Fig. 7 - Quadrifilar antenna radiation pattern.
Antenna above an infinite ground plane.
 $h = 0.4 \text{ m}$, $N = 2$, $R_0 = 0.0125 \text{ m}$, $L_{ax} = 0.14 \text{ m}$, $P = 0.07 \text{ m}$.

—— RHCP ---- LHCP

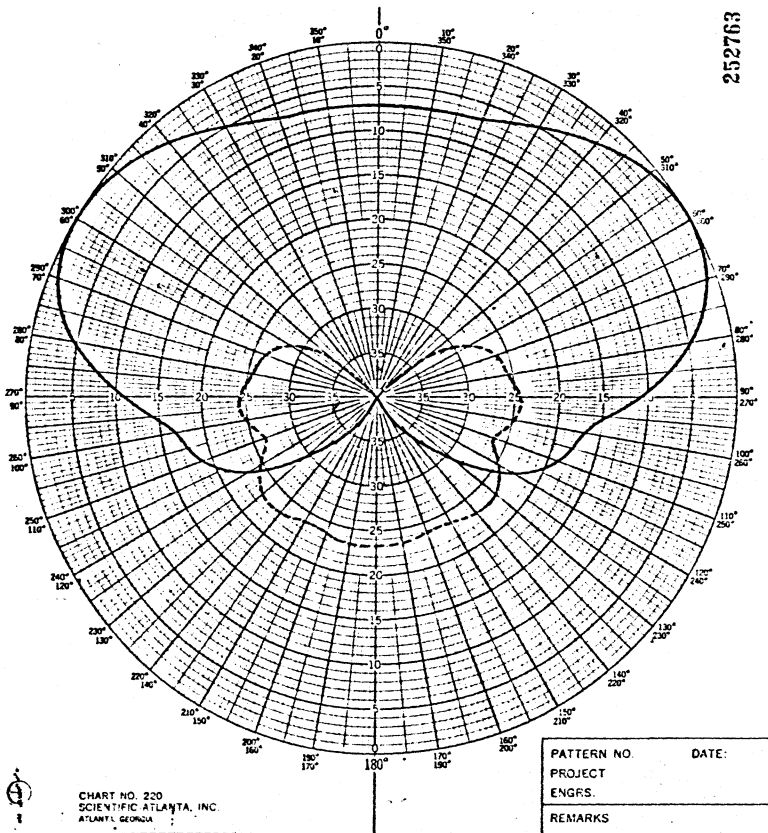

Fig. 8 - Quadrifilar antenna radiation pattern.
 $N = 3$, $R_0 = 0.0125 \text{ m}$, $L_{ax} = 0.2298 \text{ m}$, $P = 0.0767 \text{ m}$.

—— RHCP ---- LHCP

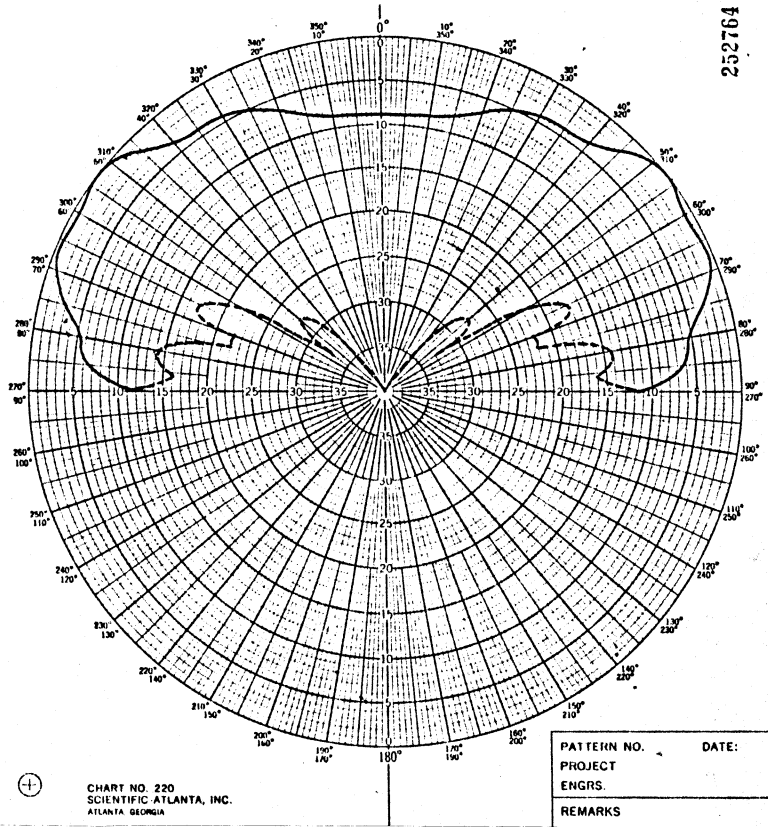

Fig. 9 - Quadrifilar antenna radiation pattern.
 Antenna above an infinite ground plane.
 $h = 0.05 \text{ m}$, $N = 3$, $R_0 = 0.0125 \text{ m}$, $L_{ax} = 0.2298 \text{ m}$, $P = 0.2298 \text{ m}$.
 ——— RHCP - - - - LHCP

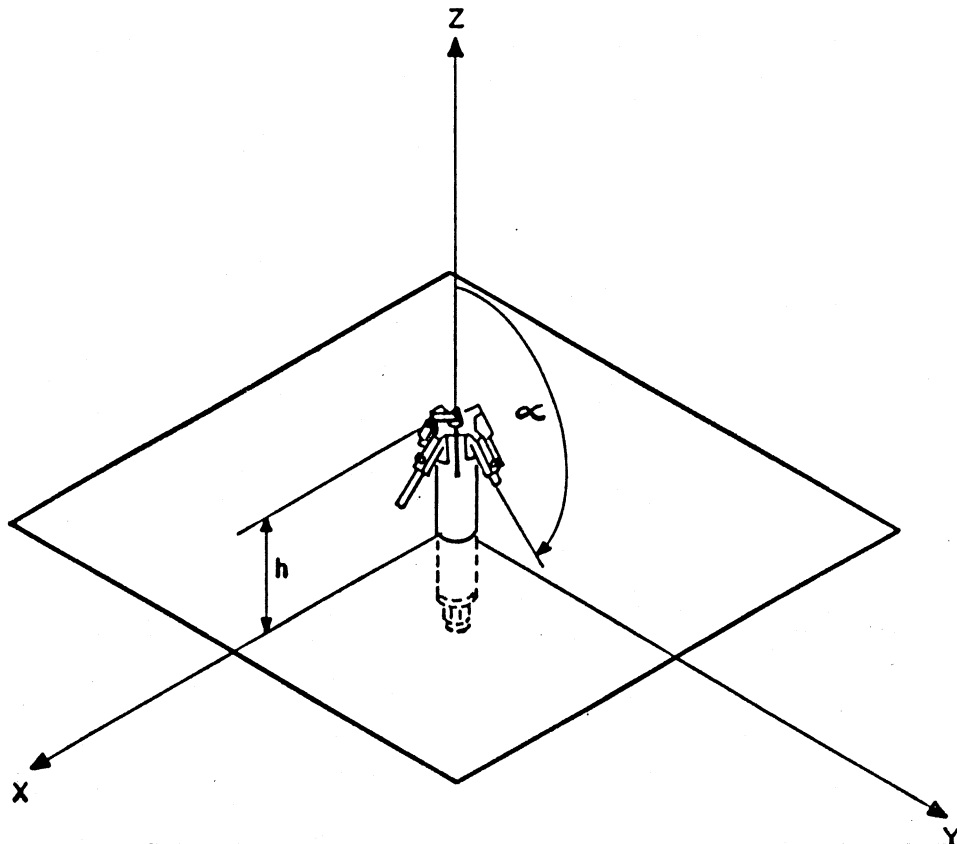

Fig. 10 - Crossed dipoles antenna.

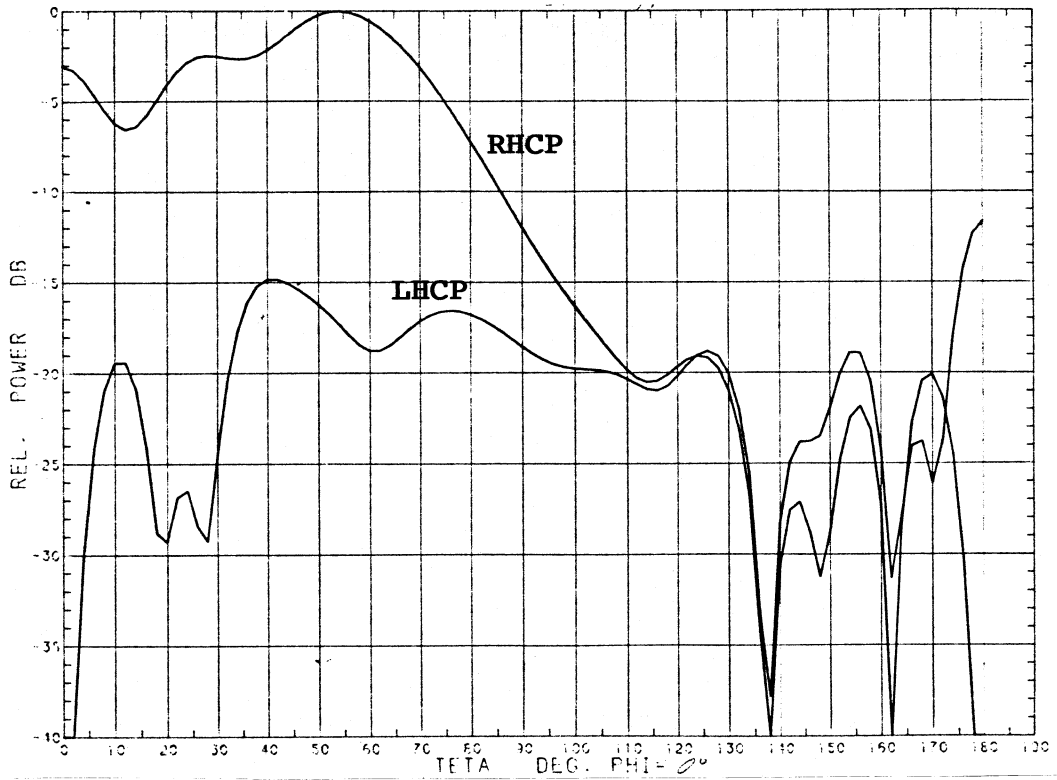

Fig. 11 - Crossed dipoles theoretical radiation pattern.

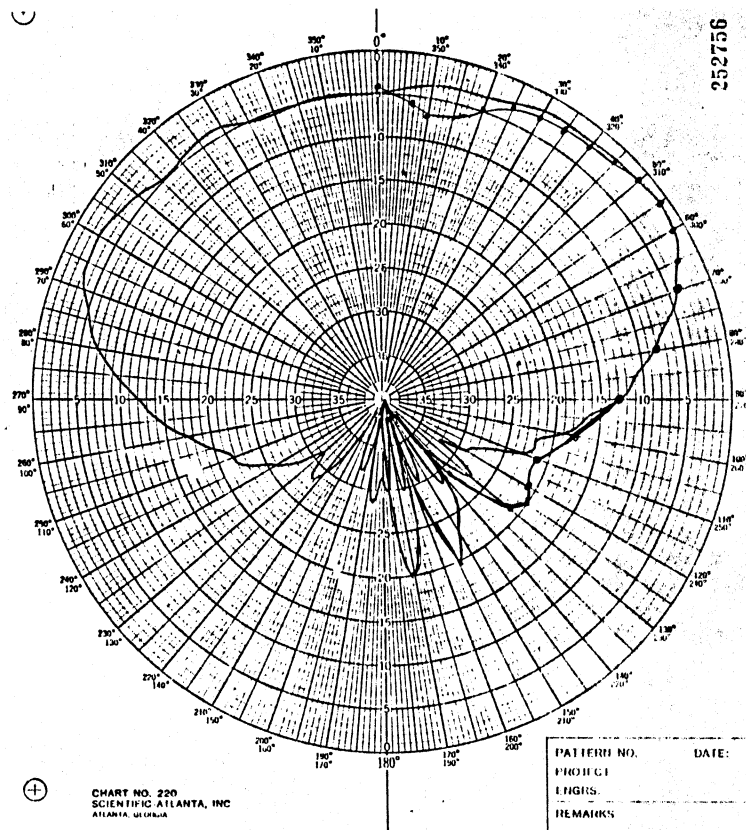

Fig. 12 - Crossed dipoles theoretical and measured radiation patterns for RHCP polarization.

— Theoretical ••• Measured

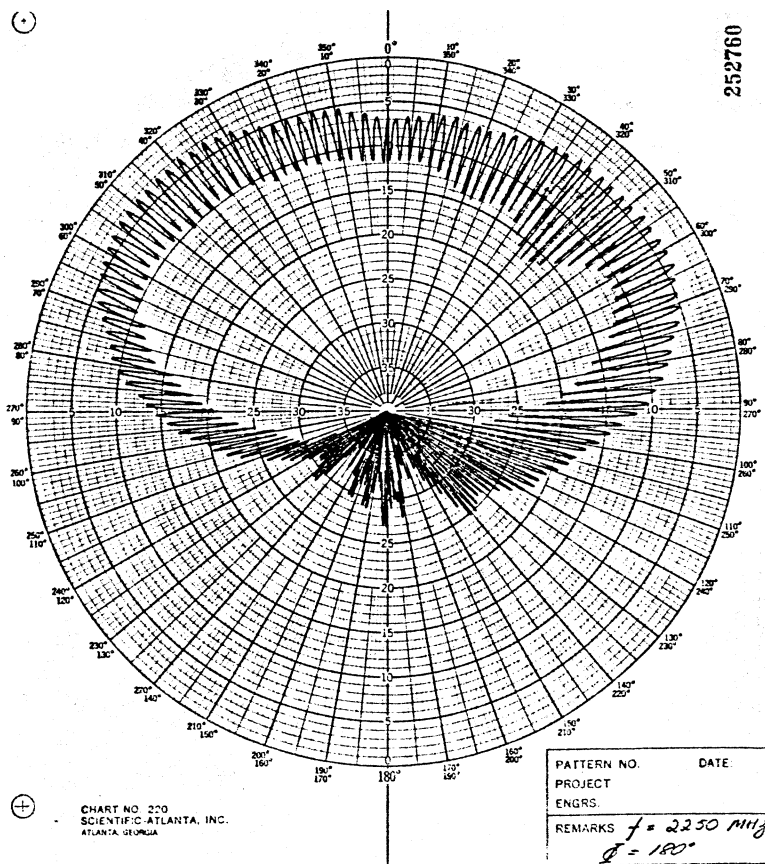

Fig. 13 - Crossed dipoles radiation pattern, Rotating Source.

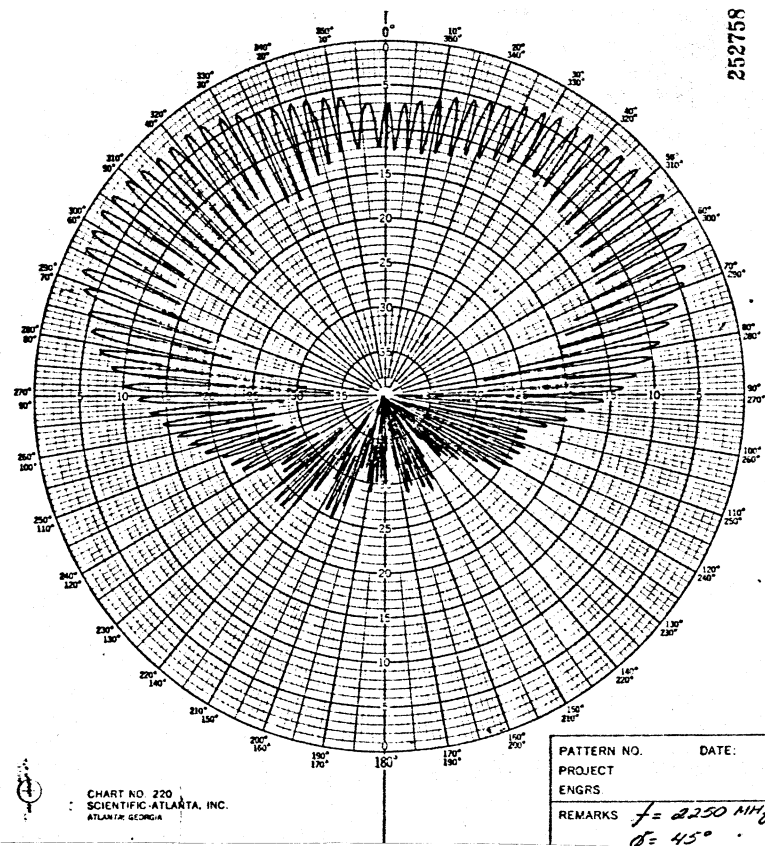

Fig. 14 - Crossed dipoles radiation pattern, Rotating Source.

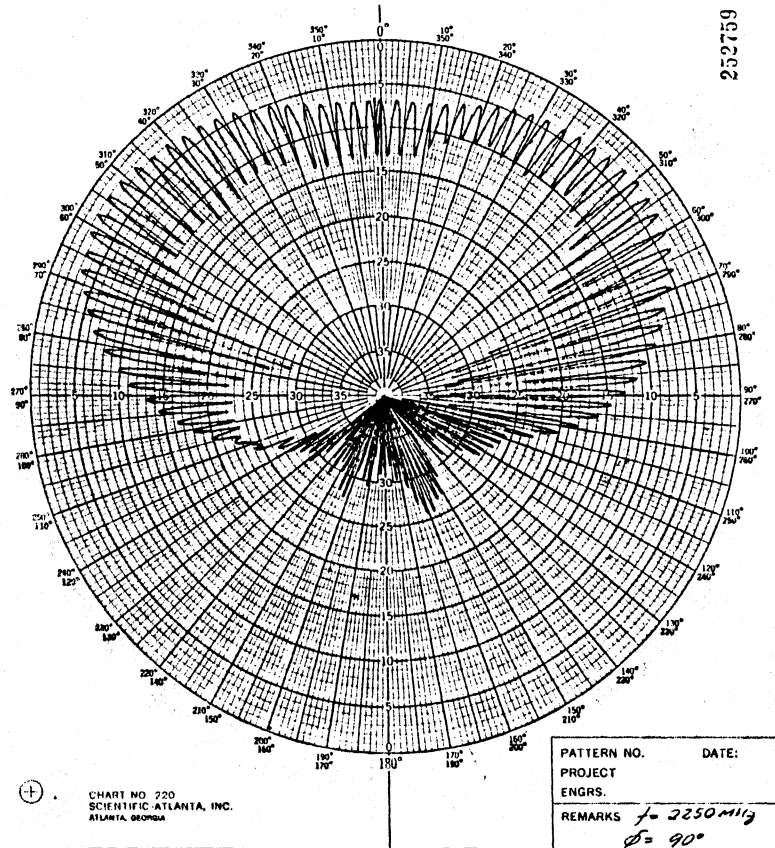

Fig. 15 - Crossed dipoles radiation pattern, Rotating Source.

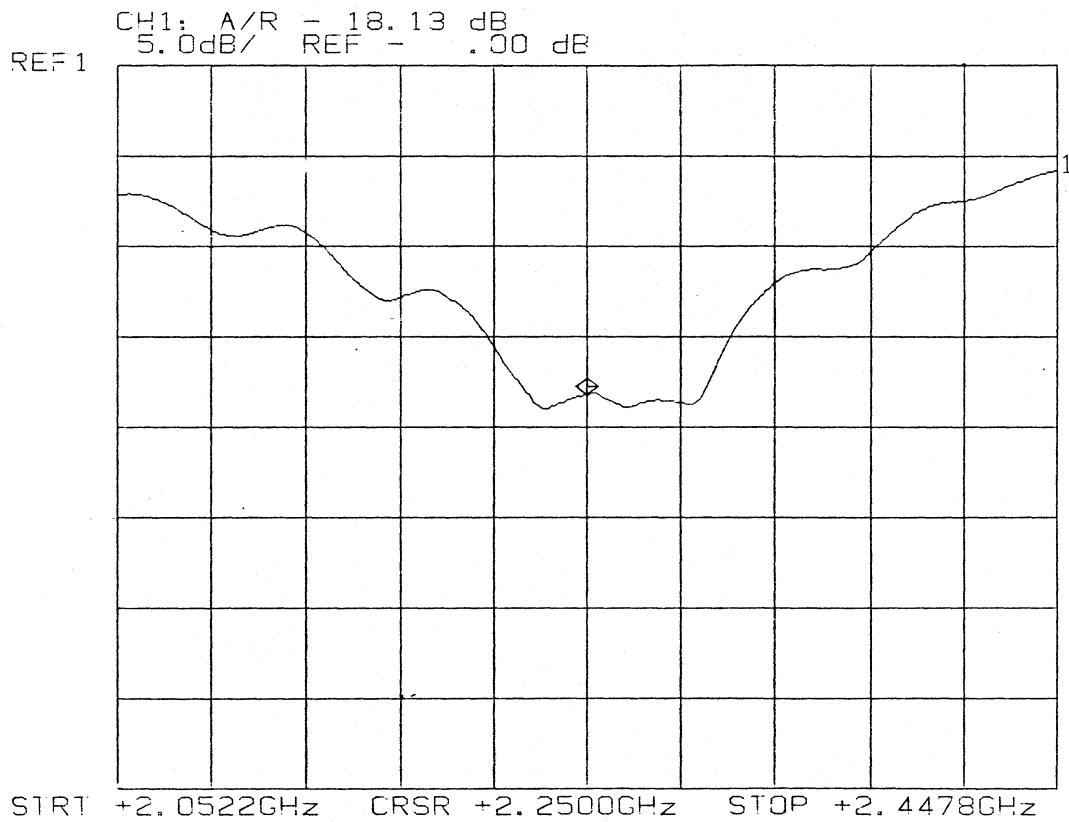

Fig. 16 - Crossed dipoles return loss.